

**Operating manual**  
**Ultrasonic proximity switch with one analogue output and one Push-Pull switching output or optionally with two switching outputs**  
**cube-35/FFIU**  
**cube-130/FFIU**  
**cube-340/FFIU**

**Product Description**  
 The cube sensor offers a non-contact measurement of the distance to an object which must be positioned within the sensor's detection zone. The switching output is set conditional upon the adjusted switching distance

and depending on the set window limits, a distance-proportional analogue signal is output. The analogue output on pin 2 can optionally be deactivated and a second Push-Pull switching output activated instead.

- Safety Notes**
- Read the operating manual prior to start-up.
  - Connection, installation and adjustments may only be carried out by qualified staff.
  - No safety component in accordance with the EU Machine Directive, use in the area of personal and machine protection not permitted.

**Proper Use**  
 cube ultrasonic sensors are used for non-contact detection of objects.

**IO-Link**  
 The cube sensor is IO-Link-capable in accordance with IO-Link specification V1.1 and supports Smart Sensor Profile like Measuring and Switching Sensor. The sensor can be monitored and parameterised via IO-Link.

- Installation**
- ➔ Mount the sensor at the place of fitting, see »QuickLock mounting bracket«.
  - ➔ Connect a connection cable to the M12 device plug, see Fig. 2.
  - ➔ If necessary, use the alignment assistance (see »Using the Alignment Assistance«).

- Start-up**
- ➔ Connect the power supply.
  - ➔ Set the parameters of the sensor, see Diagram 1 and Diagram 2.

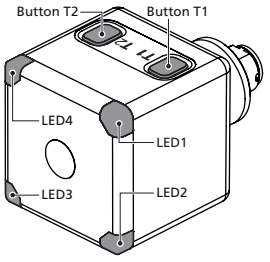

Fig. 1: Controls of the cube sensor

**Controls of the cube sensor**  
 The sensor can be operated using the push buttons T1 and T2. Four LEDs

indicate the operation and the states of the outputs, see Fig. 1 and Fig. 3.

- Output Level**  
 The sensor has two output levels:
- Analogue output and one Push-Pull switching output
  - Two Push-Pull switching outputs
- ➔ If the sensor should operate with two Push-Pull switching outputs, follow the diagram »Switching the output on pin 2«, see Diagram 2.

**Operating Modes**  
 Three operating modes are available for the switching outputs:

- **Operation with one switching point**  
 The switching output is set when the object falls below the set switching point.
- **Window mode**  
 The switching output is set when the object is within the window limits.
- **Two-way reflective barrier**  
 The switching output is set when the object is between sensor and fixed reflector.



microsonic notation	IO-Link notation	IO-Link Smart Sensor Profile	colour
1 +U <sub>B</sub>	L+		brown
2 F1/IU	Q/IU	SSC2/ASC1	white
3 -U <sub>B</sub>	L-		blue
4 F2	C/Q	SSC1	black
5 Com	NC		grey

Fig. 2: Pin assignment with view onto sensor plug, IO-Link notation and colour coding of the microsonic connection cables

LED	Colour	Indicator	LED...	Meaning
LED1	yellow	state of output pin 2	on	analogue output on pin 2
			off	object within window limits
			off	object outside window limits
LED2	green	output mode pin 2	on	switching output on pin 2 (F1)
			off	output is set
LED3	green	power indicator	on	output is not set
			off	output is set
LED4	yellow	state of output pin 4 (F2)	on	analogue output on pin 2
			off	switching output on pin 2
LED4	yellow	state of output pin 4 (F2)	on	normal operating mode
			off	IO-Link mode
LED4	yellow	state of output pin 4 (F2)	flashing on	output is set
			flashing off	output is not set

Fig. 3: Description of the LED indicators

**Synchronisation**  
 If the assembly distance of multiple sensors falls below the values shown in Fig. 4, they can influence one another. To avoid this, the internal syn-

chronisation should be used (»sync« must be switched on, see Diagram 2). Interconnect each pin 5 of the sensors to be synchronised.

Diagram 1: Set switching output F2 and analogue output via Teach-in procedure

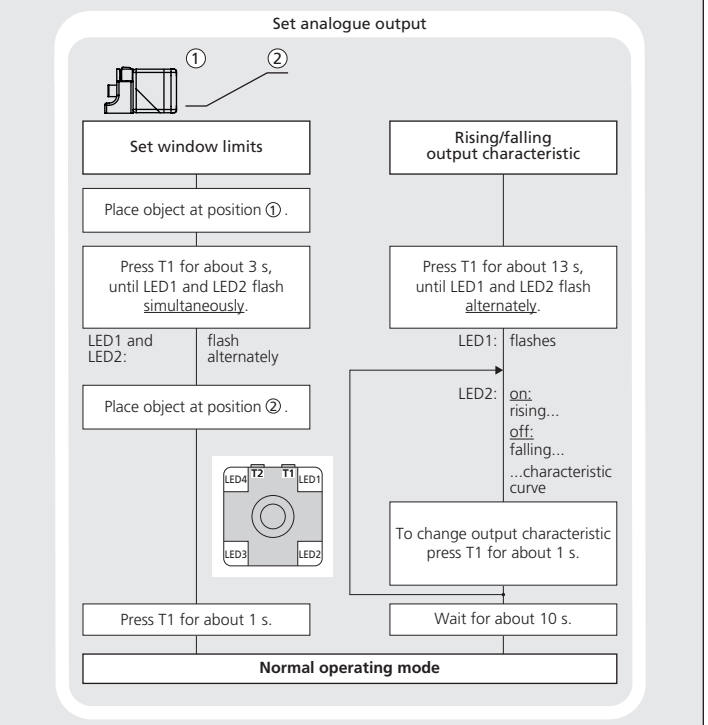
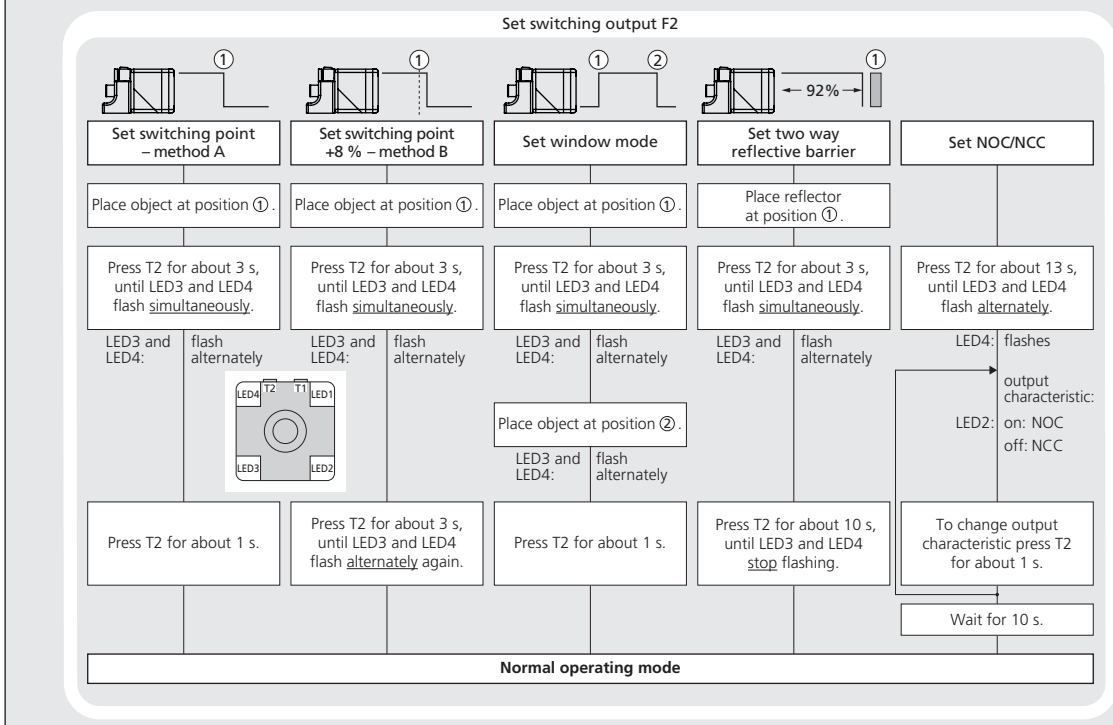

Model	Minimal distance	Maximal distance
cube-35...	≥0.40 m	≥2.50 m
cube-130...	≥1.10 m	≥8.00 m
cube-340...	≥2.00 m	≥18.00 m

Fig. 4: Minimal assembly distances without synchronisation

**QuickLock mounting bracket**  
 The cube sensor is attached using the QuickLock mounting bracket:  
 ➔ Insert the sensor into the bracket according to Fig. 5 and press until the bracket audibly engages.

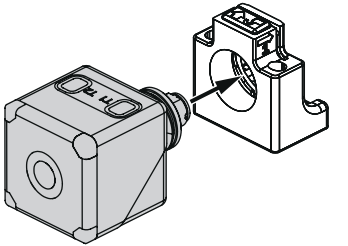

Fig. 5: QuickLock mounting bracket: insert Sensor

The sensor can be rotated around its own axis when inserted into the bracket. Furthermore, the sensor head can be rotated so that measurements can be taken in four different directions, see »Rotatable sensor head«. The bracket can be locked:

→ Slide the latch (Fig. 6) in the direction of the sensor.

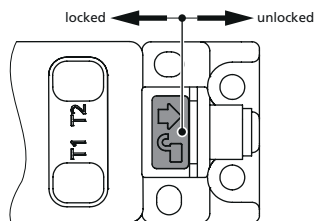

Fig. 6: QuickLock mounting bracket: lock/unlock Sensor

Remove the sensor from the QuickLock mounting bracket:

→ Unlock the latch according to Fig. 6 and press down (Fig. 7). The sensor detaches and can be removed.

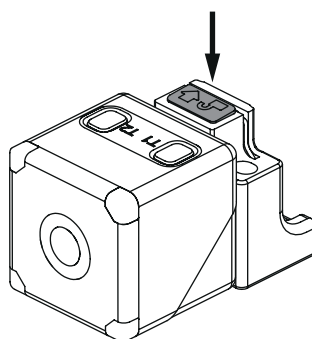

Fig. 7: Remove the sensor

### Rotatable sensor head

The cube sensor has a rotatable sensor head, with which the orientation of the sensor can be rotated by 180° (Fig. 8).

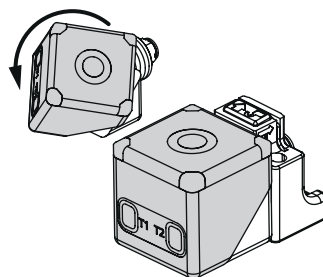

Fig. 8: Rotatable sensor head

### Factory Setting

The cube sensor is delivered factory made with the following settings:

- Analogue output + Push-Pull switching output
- Analogue output on operating mode switching automatically
- Analogue window at maximum value of the blind zone and operating range
- Switching output on operating mode switching point
- Switching output on NOC
- Switching distance at operating range
- Input Com set to »sync«
- Filter at F01
- Filter strength at P00

### Using the Alignment Assistance

With the internal alignment assistance the sensor can be optimally aligned to the object during installation. To do this, proceed as follows (see Fig. 9):

→ Mount the sensor loosely at the place of mounting so that it can still be moved.

→ Press T2 shortly. LED4 flashes. The faster the LED4 flashes, the stronger the received signal.

→ Point the sensor at different angles to the object for about 10 seconds so that the sensor can determine the maximum signal level. Afterwards align the sensor until LED4 lights constantly.

→ Screw the sensor in this position.

→ Press T2 shortly (or wait approx. 120 s) to exit the Alignment Assistance. LED3 flashes 2x and the sensor returns to normal operating mode.

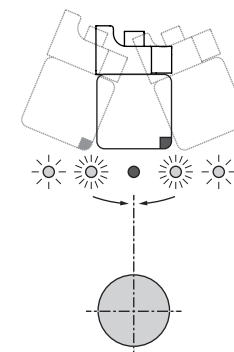
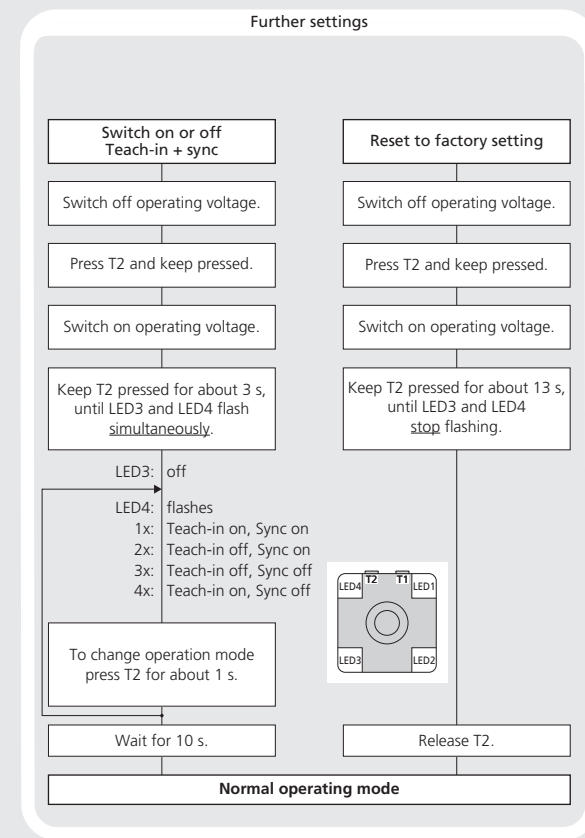
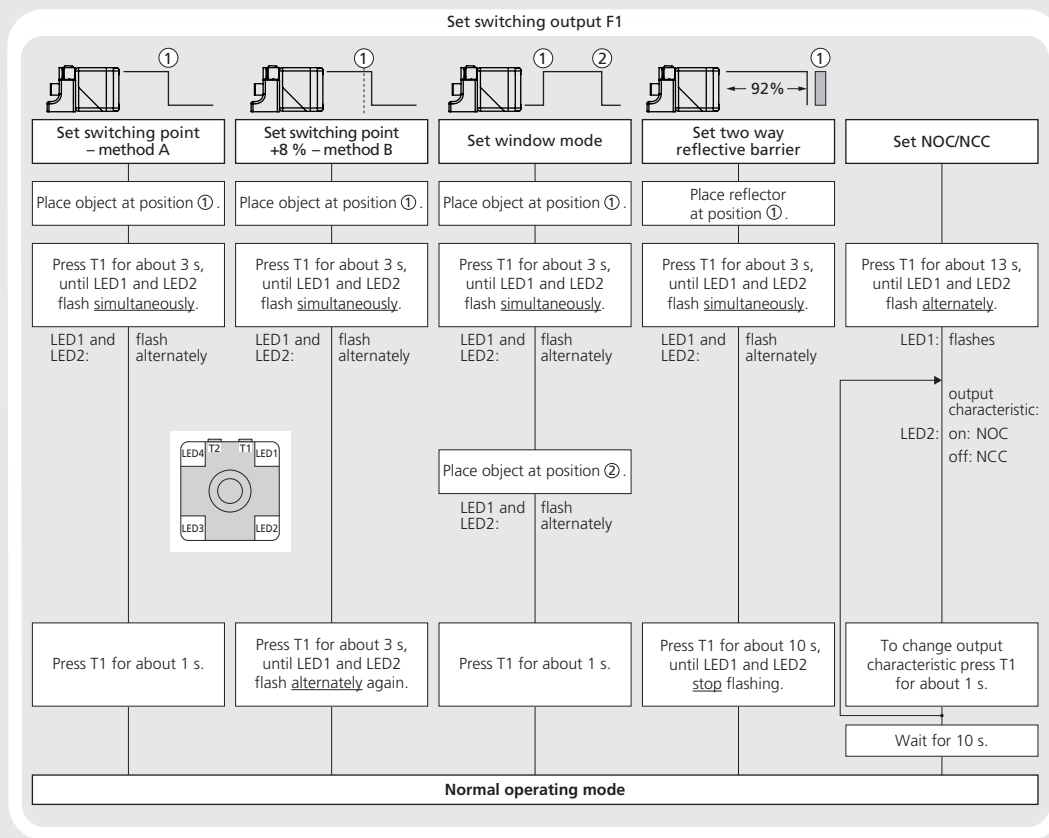
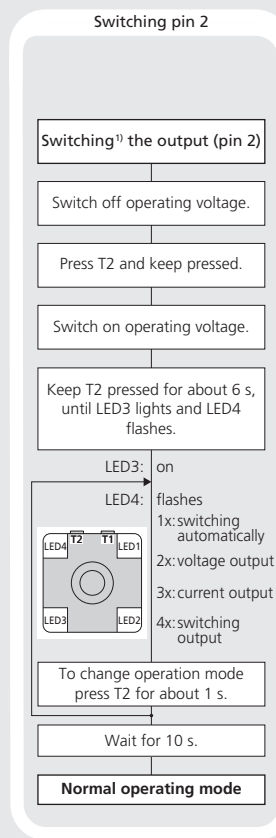

Fig. 9: Align the sensor optimally

## Diagram 2: Switch over pin 2, set switching output F1 via Teach-in procedure and further settings



<sup>1)</sup> When switching over pin 2 to switching output, +U<sub>a</sub> is present at pin 2 in the switched state.

## Technical data

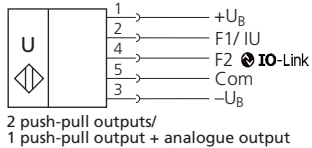

### cube-35...

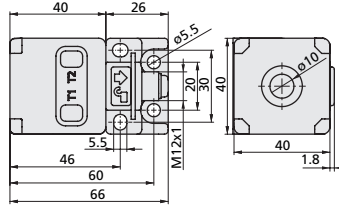

<b>blind zone</b>	0 to 65 mm
<b>operating range</b>	350 mm
<b>maximum range</b>	600 mm
<b>angle of beam spread</b>	see detection zone
<b>transducer frequency</b>	400 kHz
<b>measurement resolution</b>	0.056 mm
<b>digital resolution</b>	0.1 mm
<b>analogue resolution 1)</b>	±0.17 mm
<b>reproducibility</b>	±0.15 %

for different objects:  
The dark grey areas represent the zone where it is easy to recognise the normal reflector (round bar). This indicates the typical operating range of the sensors. The light grey areas represent the zone where a very large reflector – for instance a plate – can still be recognised. The requirement here is for an optimum alignment to the sensor. It is not possible to evaluate ultrasonic reflections outside this area.

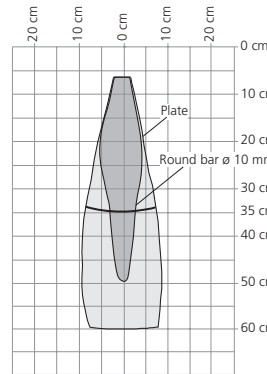

<b>accuracy</b>	±1 % (Temperature drift internal compensated, may be deactivated 2), 0.17%/K without compensation) 9 to 30 V DC, reverse polarity protection (Class 2)
<b>operating voltage U<sub>B</sub></b>	±10 %
<b>voltage ripple</b>	±50 mA
<b>no-load supply current</b>	PA, Ultrasonic transducer: polyurethane foam, epoxy resin with glass content
<b>housing</b>	IP 67
<b>class of protection to EN 60529</b>	EN 60947-5-2
<b>norm conformity</b>	5-pin initiator plug, PBT
<b>type of connection</b>	2 push-buttons
<b>controls</b>	2x LED green, 2x LED yellow
<b>indicators</b>	Teach-in via push button, LinkControl, IO-Link
<b>programmable</b>	V1.1
<b>IO-Link</b>	-25 to +70 °C
<b>operating temperature</b>	-40 to +85 °C
<b>storage temperature</b>	120 g
<b>weight</b>	5 mm
<b>switching hysteresis 2)</b>	12 Hz
<b>switching frequency 3)</b>	64 ms
<b>response time 3)</b>	<300 ms
<b>time delay before availability</b>	

<b>order No.</b>	<b>cube-35/FFIU</b>
<b>switching outputs</b>	2 x push pull, U <sub>B</sub> =3 V, -U <sub>B</sub> +3 V, I <sub>max</sub> = 2 x 100 mA switchable NOC/NCC, short-circuit-proof
<b>current output 4 to 20 mA</b>	R <sub>i</sub> ≤ 100 Ω at 9 V ≤ U <sub>B</sub> ≤ 20 V; R <sub>i</sub> ≤ 500 Ω at U <sub>B</sub> ≥ 20 V
<b>voltage output 0 to 10 V</b>	Rising/falling output characteristic R <sub>i</sub> ≥ 100 kΩ at U <sub>B</sub> ≥ 15 V, short-circuit-proof Rising/falling output characteristic

### cube-130...

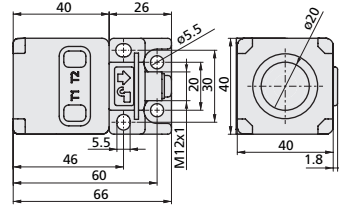

<b>blind zone</b>	0 to 200 mm
<b>operating range</b>	1,300 mm
<b>maximum range</b>	2,000 mm
<b>angle of beam spread</b>	see detection zone
<b>transducer frequency</b>	200 kHz
<b>measurement resolution</b>	0.224 mm
<b>digital resolution</b>	1.0 mm
<b>analogue resolution 1)</b>	±1.0 mm
<b>reproducibility</b>	±0.15 %

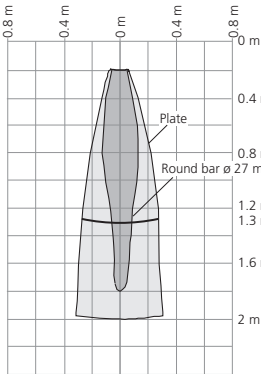

<b>accuracy</b>	±1 % (Temperature drift internal compensated, may be deactivated 2), 0.17%/K without compensation) 9 to 30 V DC, reverse polarity protection (Class 2)
<b>operating voltage U<sub>B</sub></b>	±10 %
<b>voltage ripple</b>	±50 mA
<b>no-load supply current</b>	PA, Ultrasonic transducer: polyurethane foam, epoxy resin with glass content
<b>housing</b>	IP 67
<b>class of protection to EN 60529</b>	EN 60947-5-2
<b>norm conformity</b>	5-pin initiator plug, PBT
<b>type of connection</b>	2 push-buttons
<b>controls</b>	2x LED green, 2x LED yellow
<b>indicators</b>	Teach-in via push button, LinkControl, IO-Link
<b>programmable</b>	V1.1
<b>IO-Link</b>	-25 to +70 °C
<b>operating temperature</b>	-40 to +85 °C
<b>storage temperature</b>	120 g
<b>weight</b>	20 mm
<b>switching hysteresis 2)</b>	8 Hz
<b>switching frequency 3)</b>	96 ms
<b>response time 3)</b>	<300 ms
<b>time delay before availability</b>	

<b>order No.</b>	<b>cube-130/FFIU</b>
<b>switching outputs</b>	2 x push pull, U <sub>B</sub> =3 V, -U <sub>B</sub> +3 V, I <sub>max</sub> = 2 x 100 mA switchable NOC/NCC, short-circuit-proof
<b>current output 4 to 20 mA</b>	R <sub>i</sub> ≤ 100 Ω at 9 V ≤ U <sub>B</sub> ≤ 20 V; R <sub>i</sub> ≤ 500 Ω at U <sub>B</sub> ≥ 20 V
<b>voltage output 0 to 10 V</b>	Rising/falling output characteristic R <sub>i</sub> ≥ 100 kΩ at U <sub>B</sub> ≥ 15 V, short-circuit-proof Rising/falling output characteristic

### cube-340...

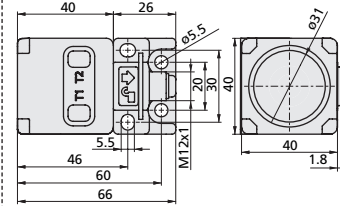

<b>blind zone</b>	0 to 350 mm
<b>operating range</b>	3,400 mm
<b>maximum range</b>	5,000 mm
<b>angle of beam spread</b>	see detection zone
<b>transducer frequency</b>	120 kHz
<b>measurement resolution</b>	0.224 mm
<b>digital resolution</b>	1.0 mm
<b>analogue resolution 1)</b>	±1.45 mm
<b>reproducibility</b>	±0.15 %

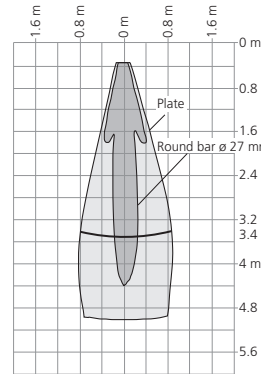

<b>accuracy</b>	±1 % (Temperature drift internal compensated, may be deactivated 2), 0.17%/K without compensation) 9 to 30 V DC, reverse polarity protection (Class 2)
<b>operating voltage U<sub>B</sub></b>	±10 %
<b>voltage ripple</b>	±50 mA
<b>no-load supply current</b>	PA, Ultrasonic transducer: polyurethane foam, epoxy resin with glass content
<b>housing</b>	IP 67
<b>class of protection to EN 60529</b>	EN 60947-5-2
<b>norm conformity</b>	5-pin initiator plug, PBT
<b>type of connection</b>	2 push-buttons
<b>controls</b>	2x LED green, 2x LED yellow
<b>indicators</b>	Teach-in via push button, LinkControl, IO-Link
<b>programmable</b>	V1.1
<b>IO-Link</b>	-25 to +70 °C
<b>operating temperature</b>	-40 to +85 °C
<b>storage temperature</b>	130 g
<b>weight</b>	50 mm
<b>switching hysteresis 2)</b>	4 Hz
<b>switching frequency 3)</b>	166 ms
<b>response time 3)</b>	<300 ms
<b>time delay before availability</b>	

<b>order No.</b>	<b>cube-340/FFIU</b>
<b>switching outputs</b>	2 x push pull, U <sub>B</sub> =3 V, -U <sub>B</sub> +3 V, I <sub>max</sub> = 2 x 100 mA switchable NOC/NCC, short-circuit-proof
<b>current output 4 to 20 mA</b>	R <sub>i</sub> ≤ 100 Ω at 9 V ≤ U <sub>B</sub> ≤ 20 V; R <sub>i</sub> ≤ 500 Ω at U <sub>B</sub> ≥ 20 V
<b>voltage output 0 to 10 V</b>	Rising/falling output characteristic R <sub>i</sub> ≥ 100 kΩ at U <sub>B</sub> ≥ 15 V, short-circuit-proof Rising/falling output characteristic

1) Depending on the window limits.

2) Can be programmed via LinkControl and IO-Link.

3) With LinkControl and IO-Link, the selected filter setting influences the switching frequency and response time.

## Maintenance

microsonic sensors are maintenance-free. In case of excess caked-on dirt we recommend cleaning the white sensor surface.

## Notes

- The cube sensor has a blind zone, within which a distance measurement is not possible.
- The cube sensor is equipped with an internal temperature compensation. Due to the sensors self heating, the temperature compensation reaches its optimal working point after approx. 3 minutes of operation.
- The cube sensor has a push-pull switching output and an analogue output. The analogue output can be switched to a second push-pull switching output.
- The sensor automatically detects the load during start-up put to the analogue output and switches to current output or voltage output respectively.
- Choosing between rising and falling output characteristic as well as output function NOC and NCC is possible.
- In the normal operating mode the illuminated yellow LED signals that the switching output is set.
- The flashing LED3 indicates that the sensor is in IO-Link mode.
- If a Teach-in procedure is not completed, all changes are deleted after approx. 30 seconds.
- If two LEDs flash rapidly alternately for approx. 3 seconds during a teach-in procedure, the teach-in procedure was not successful and is discarded.
- In the »Two-way reflective barrier« operating mode, the object has to be within the range of 0 to 92 % of the set distance.
- In the »Set switching point – method A« Teach-in procedure the actual distance to the object is taught to the sensor as the switching point. If the object moves towards the sensor (e.g. with level control) then the taught distance is the level at which the sensor has to

switch the output.

- If the object to be scanned moves into the detection area from the side, the »Set switching point +8 % – method B« Teach-in procedure should be used. In this way the switching distance is set 8 % further than the actual measured distance to the object. This ensures a reliable switching behavior even if the height of the objects varies slightly, see Fig. 10.

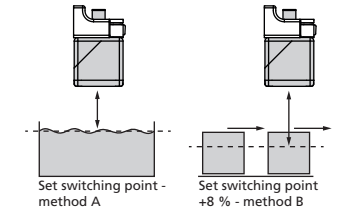

Fig. 10: Setting the switching point for different directions of movement of the object

- The sensor can be reset to its factory setting (see »Further settings«, Diagram 2).
- The cube sensor can be locked against unwanted changes in the sensor via function »Switch on or off Teach-in + sync«, see Diagram 2.
- Using the LinkControl adapter (optional accessory) and the LinkControl software for Windows®, all Teach-in and additional sensor parameter settings can be optionally adjusted.
- The latest IODD file and informations about start-up and configuration of cube sensors via IO-Link, you will find online at: [www.microsonic.de/en/cube](http://www.microsonic.de/en/cube).

## Scope of delivery

- 1x QuickLock mounting bracket

